

COMPONENTES / MONTAGEM

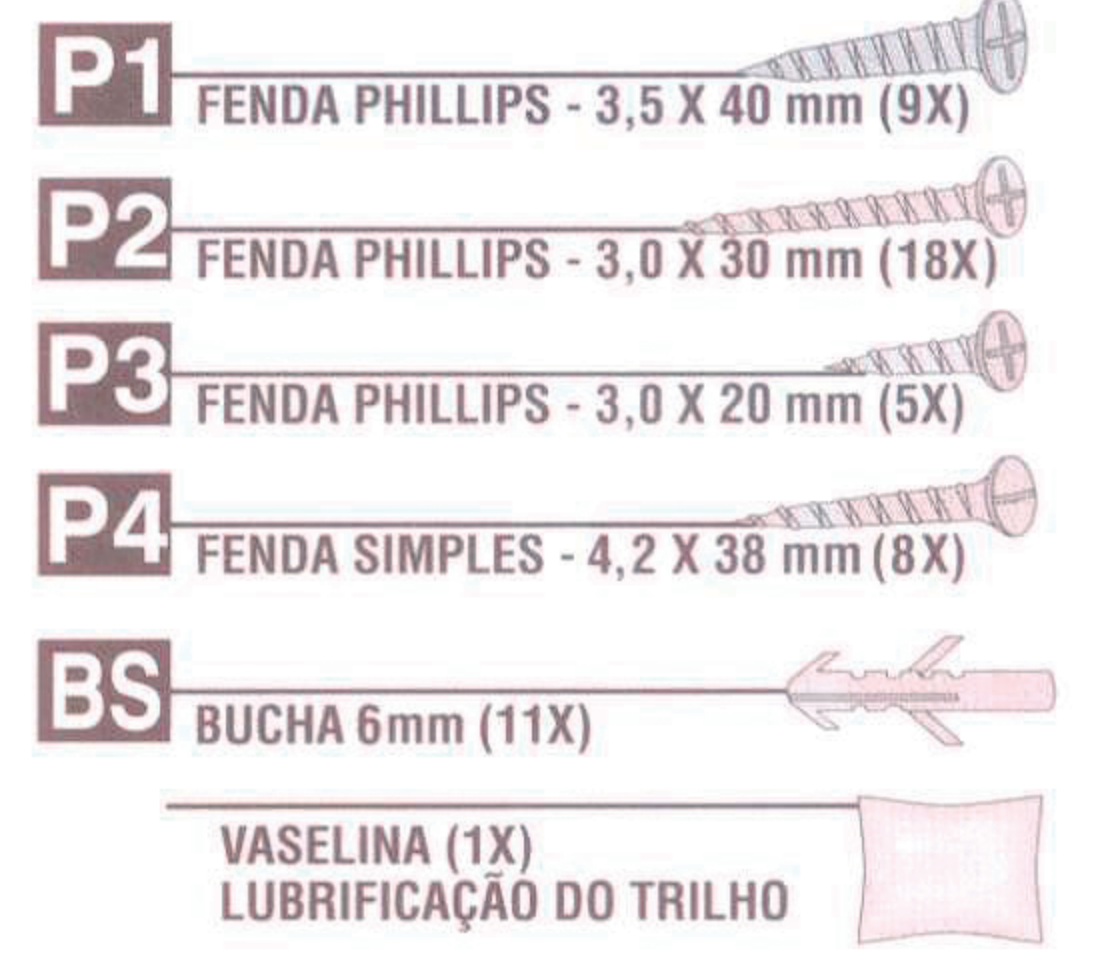

(* AS QUANTIDADES DOS ITENS: LÂMINA PRINCIPAL **D** E PERFIL DE ARTICULAÇÃO **G** VARIAM DE ACORDO COM A LARGURA DA PORTA: 0,80 X 2,10 m = 6X, 0,70 X 2,10 m = 5X, 0,60 X 2,10 m = 4X, 0,90 X 2,10 m = 7X

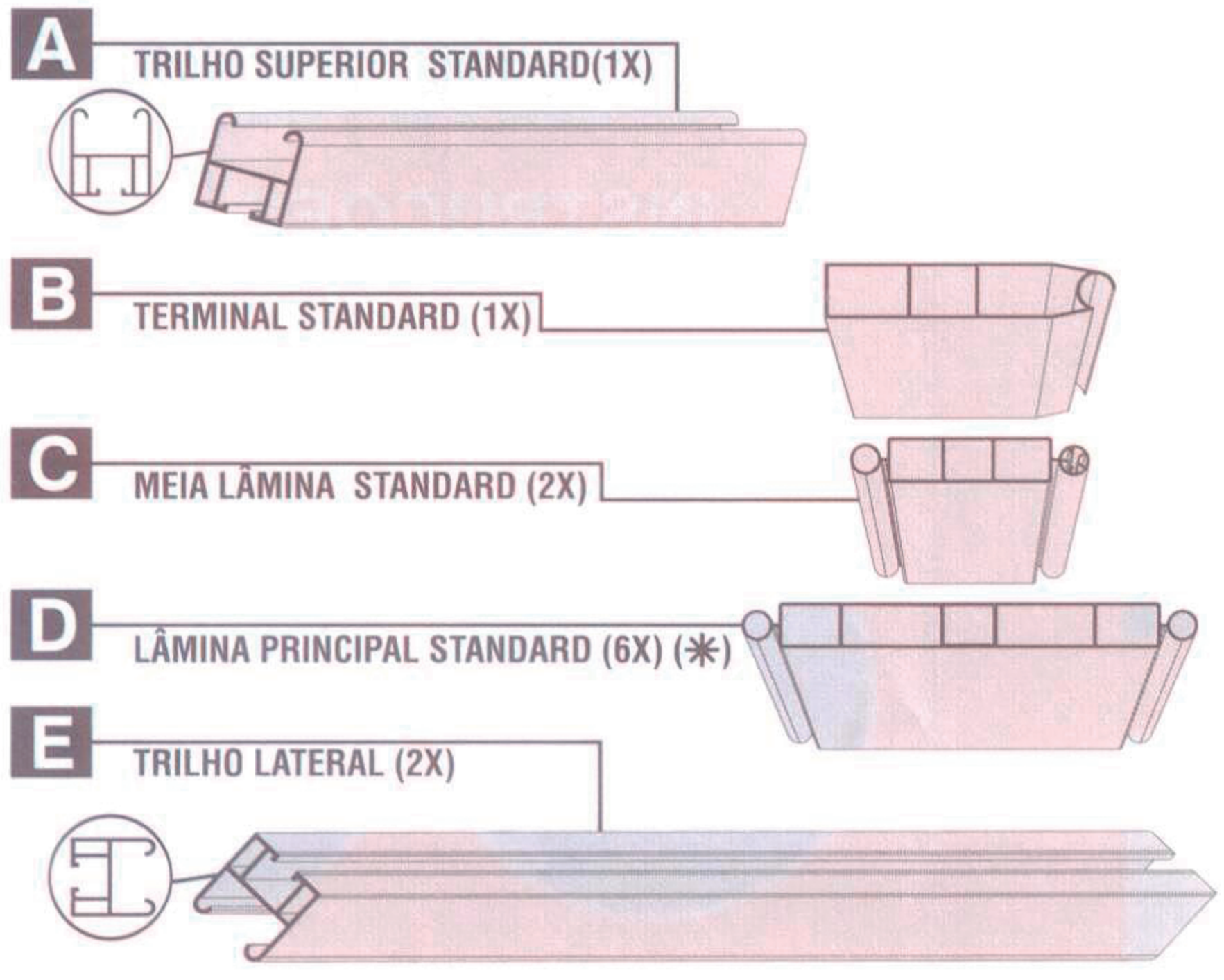
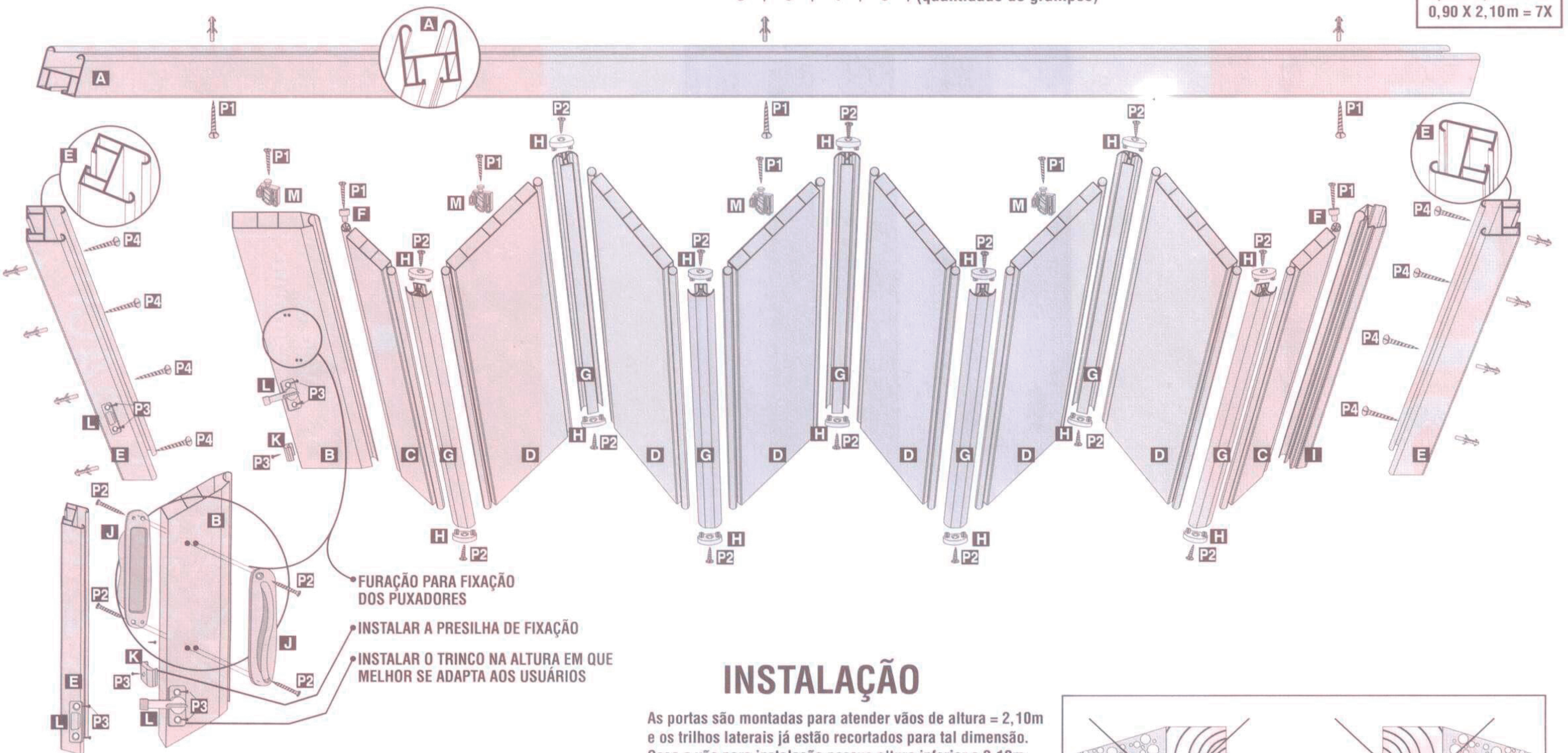

INSTALAÇÃO

As portas são montadas para atender vãos de altura = 2,10m e os trilhos laterais já estão recortados para tal dimensão. Caso o vão para instalação possua altura inferior a 2,10m siga as instruções que seguem.

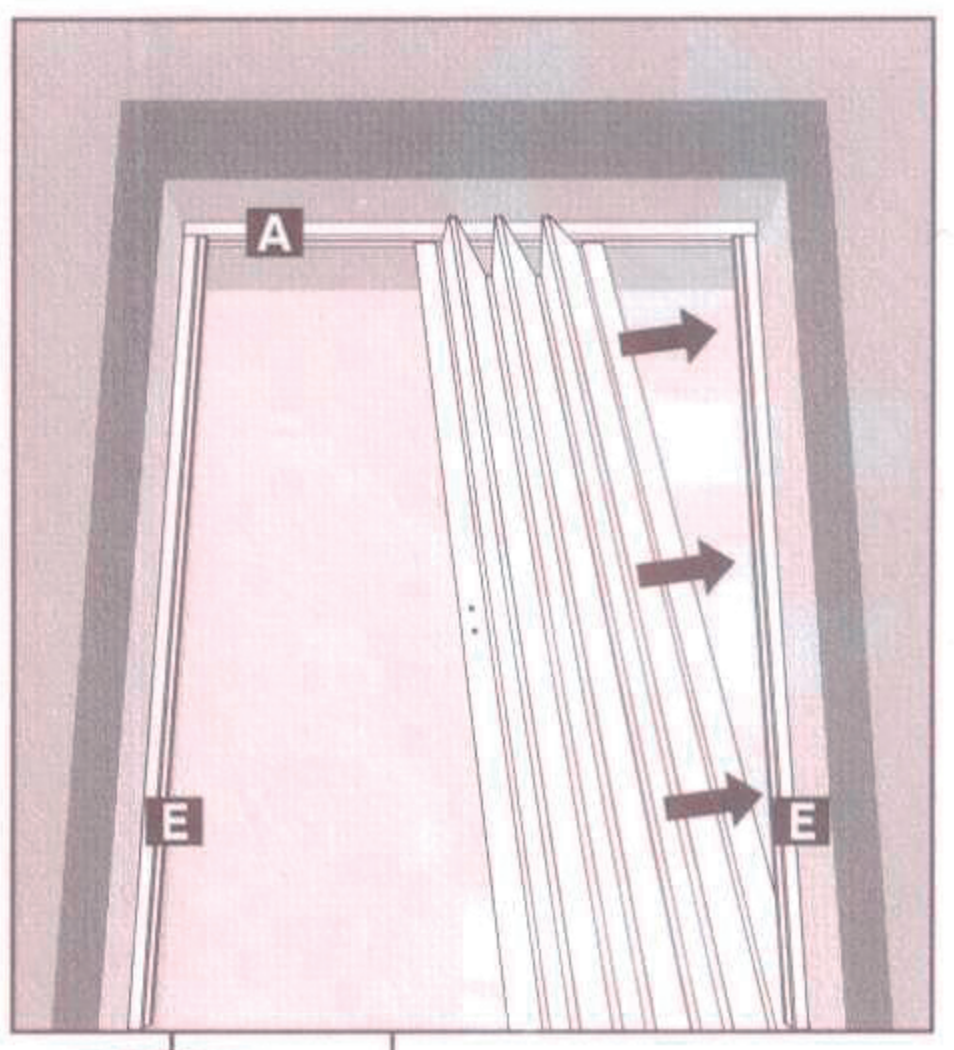
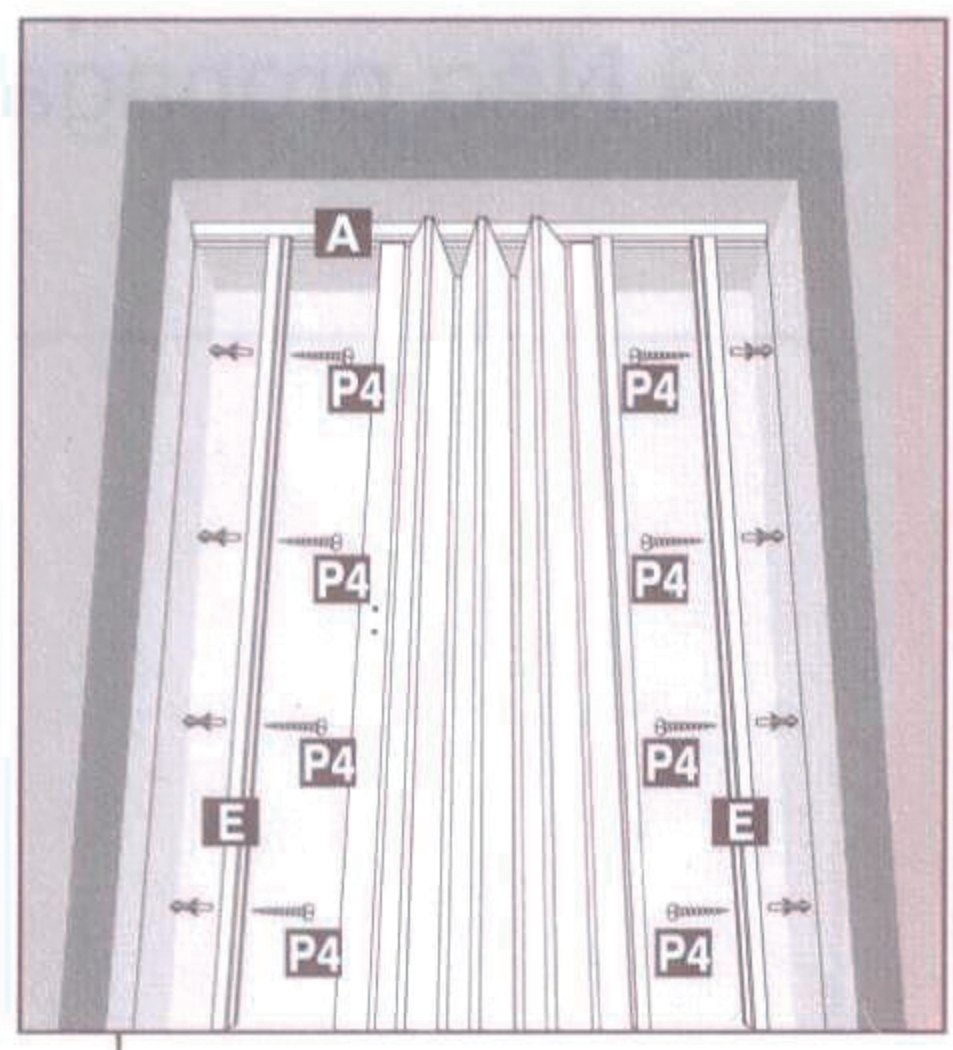
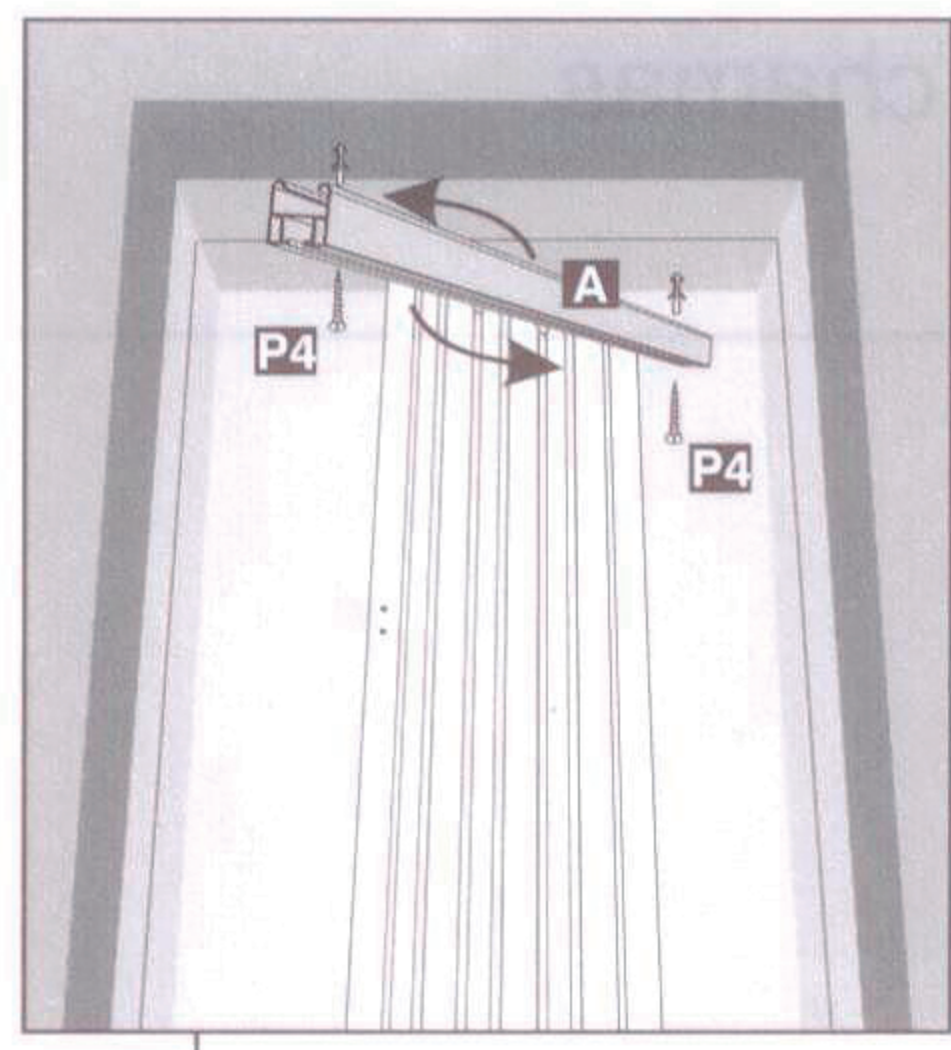
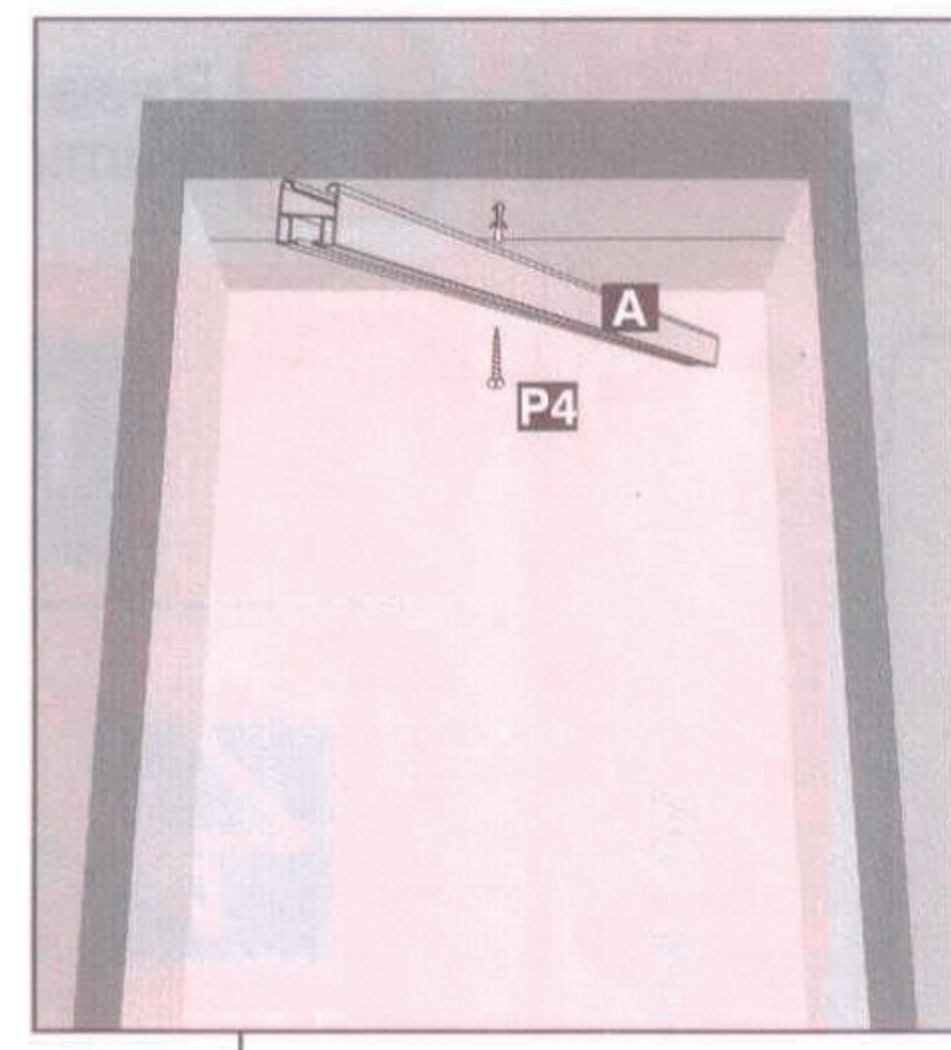
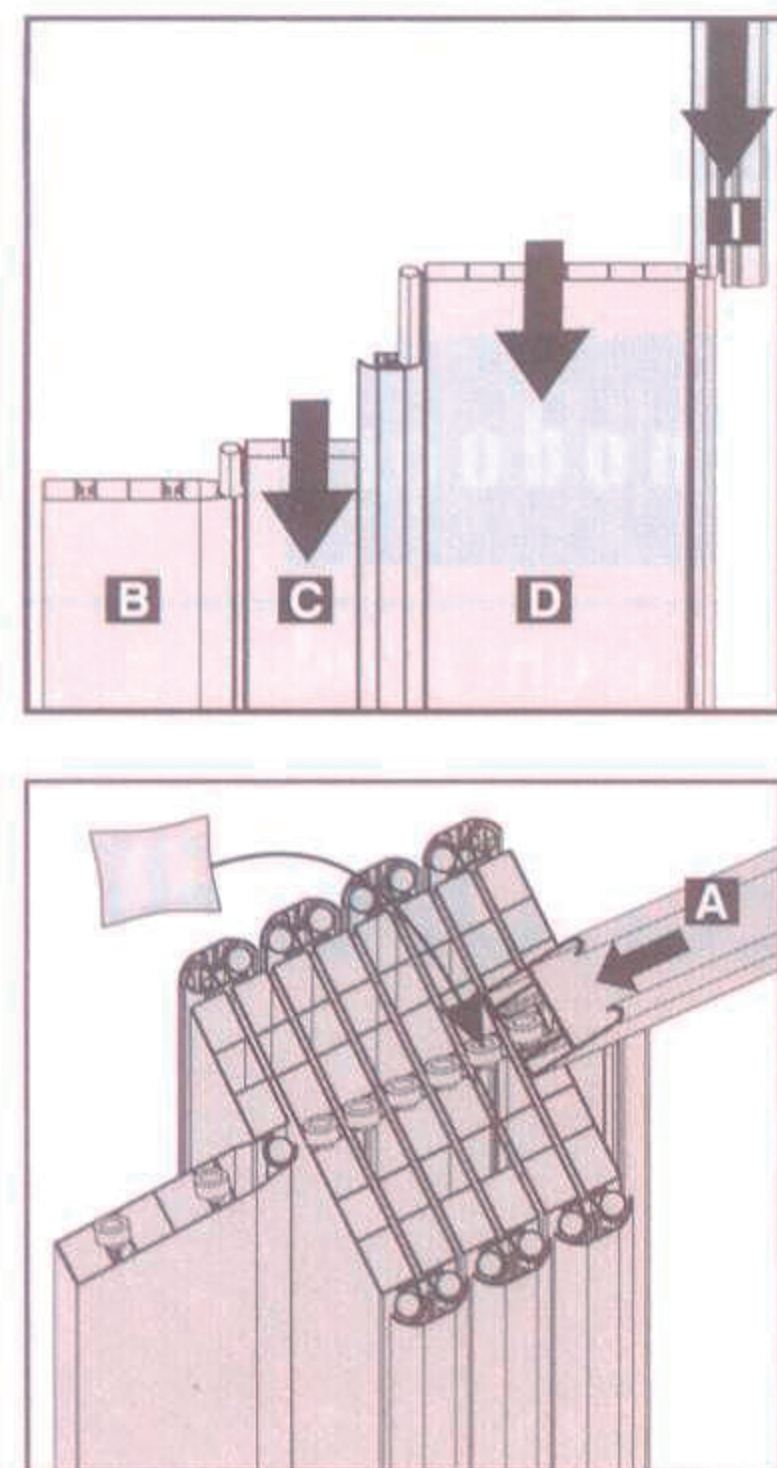
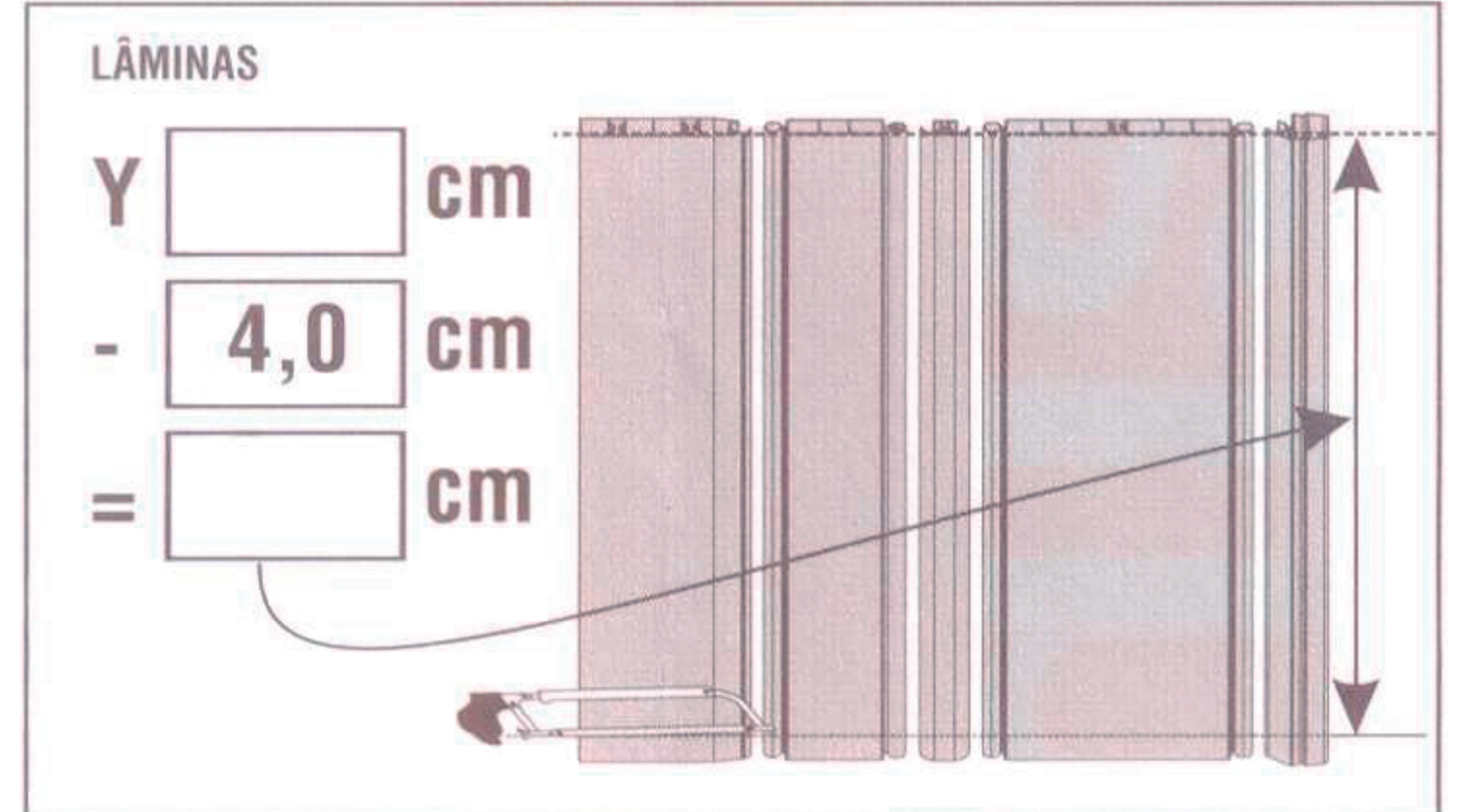
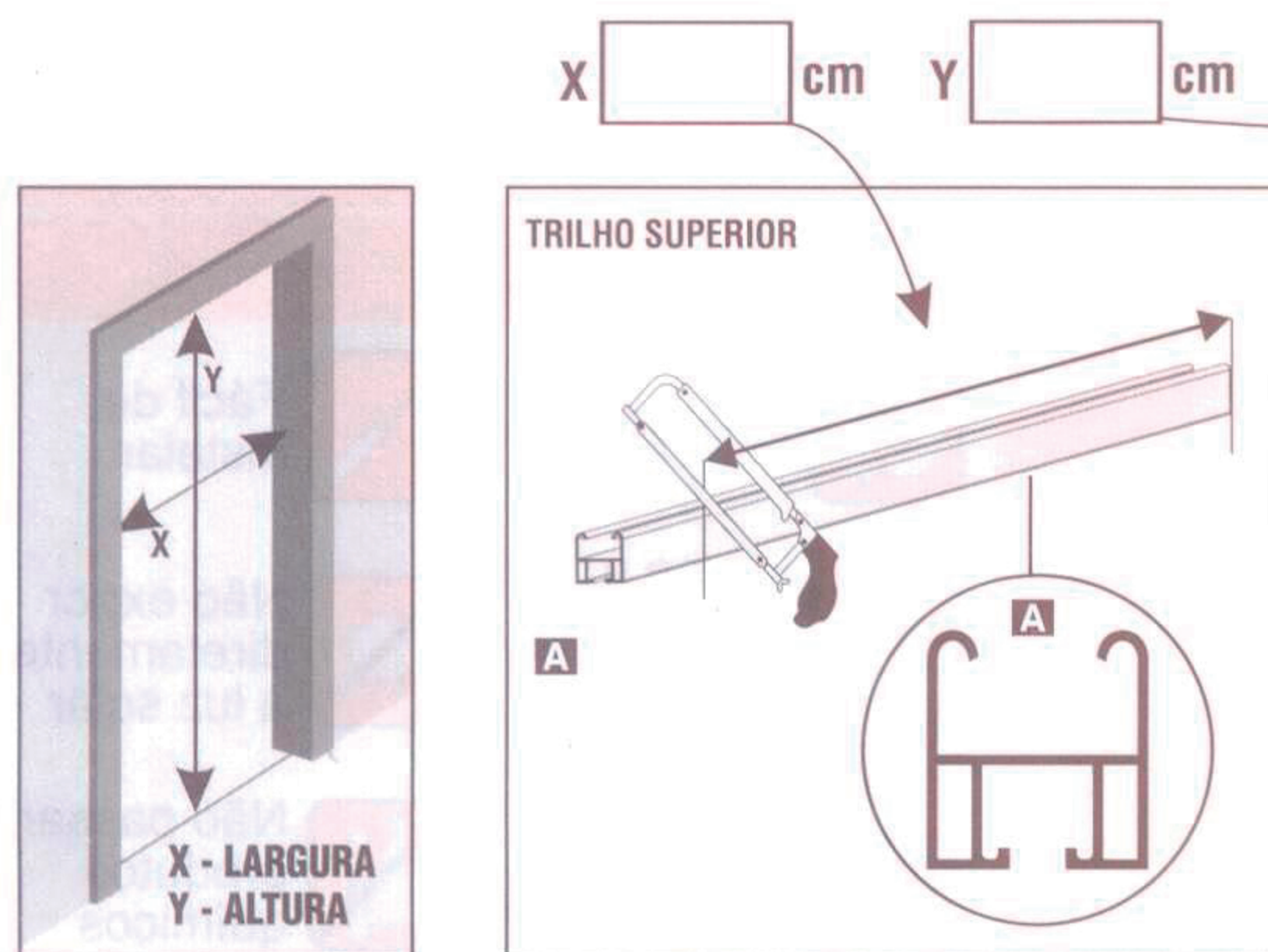

INSTALE O TRILHO SUPERIOR FIXANDO APENAS O PARAFUSO CENTRAL

GIRE O TRILHO SUPERIOR E ENCAIXE A PORTA MONTADA NO MESMO, AJUSTE NO LUGAR E FIXE OS DEMAIS PARAFUSOS

PARAFUSE OS TRILHOS LATERAIS

ENCAIXE O PERFIL DE FIXAÇÃO, CLICANDO-O NO TRILHO LATERAL OPOSTO AO DO PUXADOR

Nota: As informações contidas neste manual poderão sofrer alterações sem prévio aviso, a critério do fabricante.